

2-4 CKT

NOTES:

1. MATERIAL:  
1.1 HOUSING: THERMOPLASTIC,UL94V-0,  
COLOR:BLACK OR NATURAL ;
2. SPEC. PLS. REFER TO PS-57980-xxxx-xxx
3. PACKING QUANTITY: XXXX PCS/BAG
4. TERMINAL P/N: 57980-T57X-001
5. PART NUMBER

57960-XXX H X X X-002

CKTS ——— 002:FOR 57980-T57X-001  
 POLARIZATION ——— COLOR  
 0:NONE 0:NATURAL  
 1:BLACK  
 MATERIAL  
 H: NYLON66

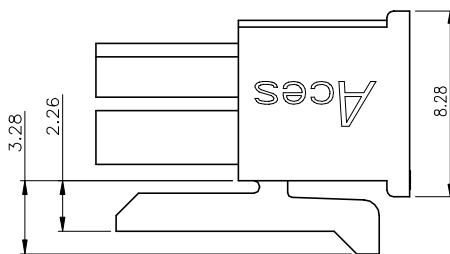
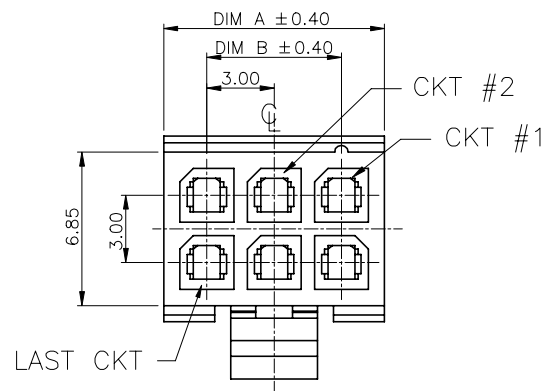

6-24 CKT

CKT	DIM A	DIM B
2	3.86	NA
4	6.85	3.00
6	9.85	6.00
8	12.85	9.00
10	15.85	12.00
12	18.85	15.00
14	21.85	18.00
16	24.85	21.00
18	27.85	24.00
20	30.85	27.00
22	33.85	30.00
24	36.85	33.00

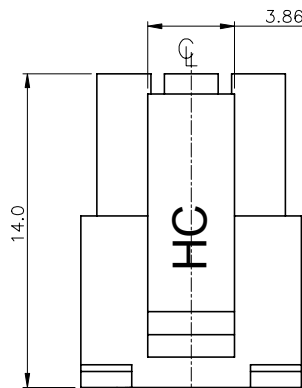

<b>QUALITY SYMBOLS</b> MAJOR Ⓢ CRITICAL Ⓢ <b>GENERAL TOLERANCES</b> (UNLESS SPECIFIED) X ±0.5 .X ±0.25 .XX ±0.15 .XXX ±0.1 ANGLES ±2°	DRAWN BY Huang,ShunSen 24/04/13	DATE 24/04/13	
	CHECKED BY Lu,Jing Quan 24/04/13	DATE 24/04/13	
	APPROVED BY hsieh,fu yu 24/04/13	DATE 24/04/13	UNITS <b>mm</b>
	SCALE <b>3:1</b>	SHEET NO. <b>1 OF 2</b>	SIZE <b>A4</b>
			RFG NO. <b>RFQ-2307099</b>
			DWG NO. <b>57960-XXXHXXX-002</b>



A

B

C

D

E

F

1

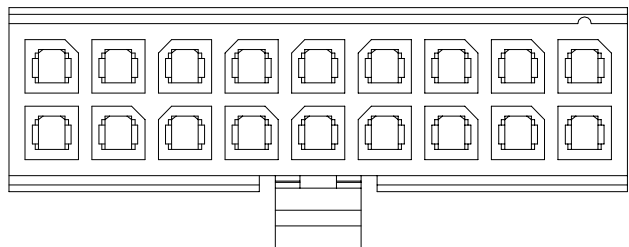

18-CKT

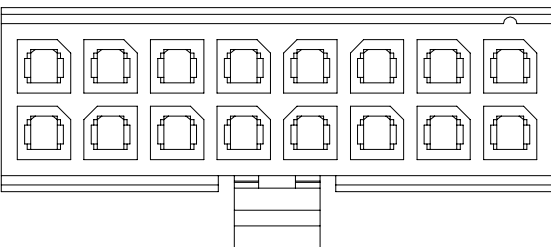

16-CKT

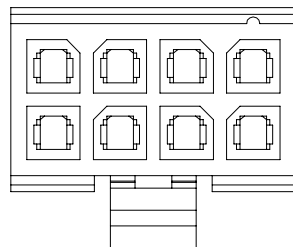

8-CKT

2

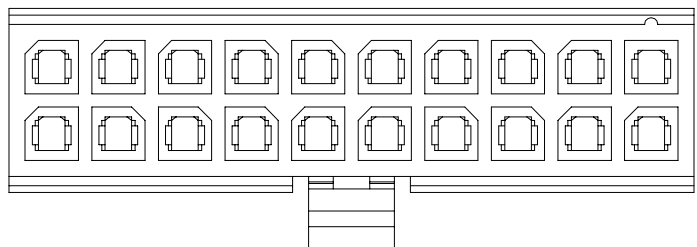

20-CKT

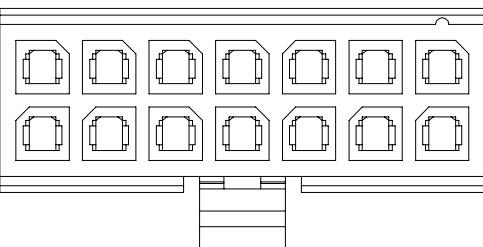

14-CKT

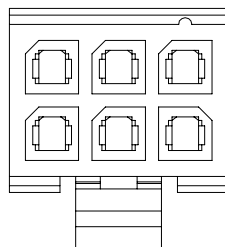

6-CKT

3

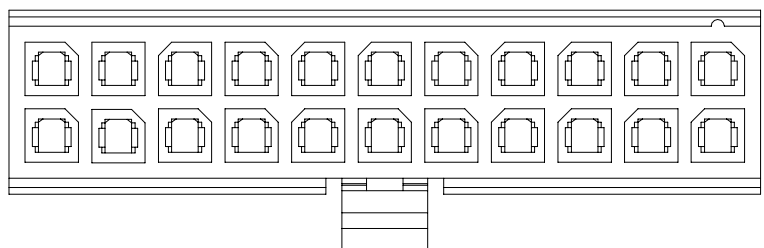

22-CKT

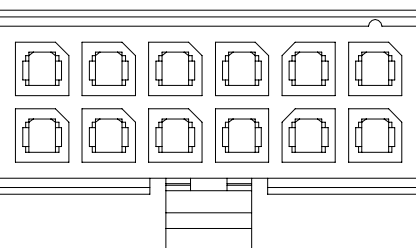

12-CKT

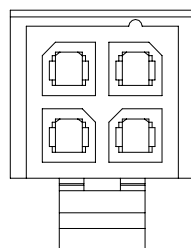

4-CKT

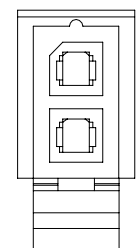

2-CKT

4

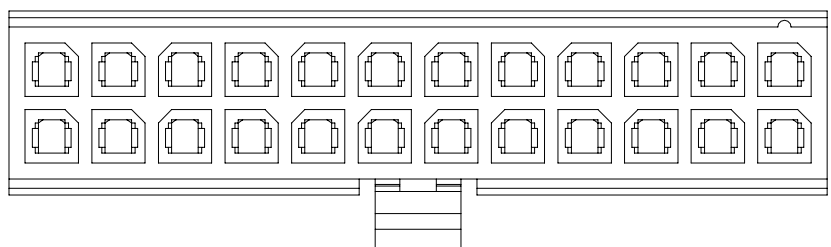

24-CKT

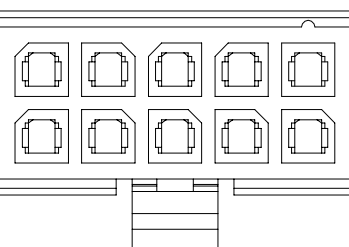

10-CKT

5

<b>QUALITY SYMBOLS</b> MAJOR CRITICAL <b>GENERAL TOLERANCES</b> (UNLESS SPECIFIED) X ±0.5 .X ±0.25 .XX ±0.15 .XXX ±0.1 ANGLES ±2°	DRAWN BY Huang,ShunSen	DATE 24/04/13	
	CHECKED BY Lu,Jing Quan	DATE 24/04/13	
	APPROVED BY hsieh,fu yu	DATE 24/04/13	RFG NO. <b>RFQ-2307099</b>
	UNITS <b>mm</b>		SIZE <b>A4</b>
	SCALE <b>3 : 1</b>	SHEET NO. <b>2 OF 2</b>	DWG NO. <b>57960-XXXHXXX-002</b>

B

C

D

E

F